

**WALK-IN CLOSET**

V1.24.13

**CRÉMAILLÈRE VERTICALE**

	Profil de crémailière verticale (2606mm) x2 pour un panneau x3 pour deux panneaux <b>CS159.101.001</b>	Supports métalliques x4 pour une crémailière <b>CS001.005.001</b>	Clip en plastique x8 pour un panneau <b>CS001.004.001</b>
--	---	---	---

**ÉTAGÈRE À CHAUSSURES**

	Support Porte-chaussures x2 pour une étagère x3 pour deux étagères <b>CS001.010.007</b>	Set de profils de porte-chaussures <b>HP155.101.002</b>	Kit de supports pour étagère en bois ép. 25mm min Fixation externe <b>CS001.012.001</b> Fixation centrale <b>CS001.012.002</b>
--	--	--	--

**SUPPORTS POUR NICHE**

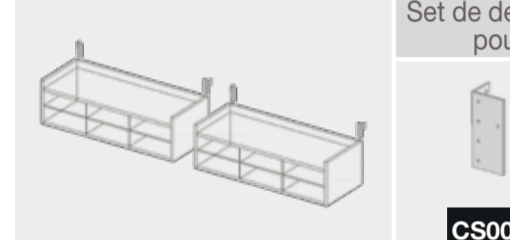
	Set de deux supports pour niche <b>CS001.124.002</b>
---	---

**SUPPORTS POUR COMMODE**

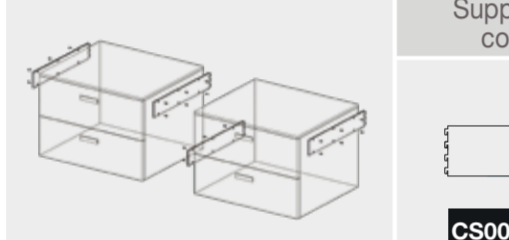
	Supports pour commode x2 pour une commode <b>CS001.120.002</b>
--	--

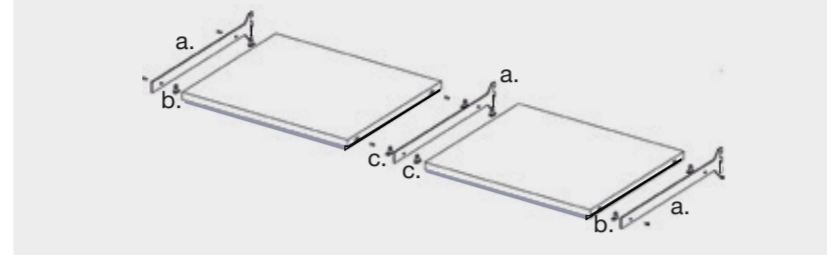

**PANNEAU DE BASE**

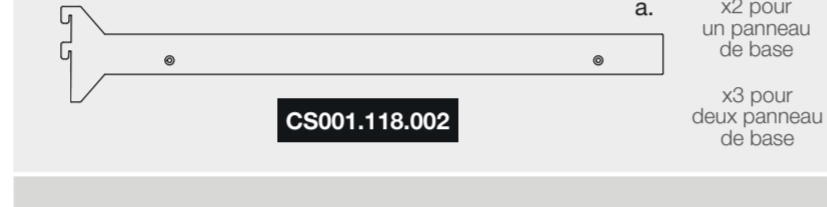
	Supports pour panneau de base <b>CS001.118.002</b>
--	---

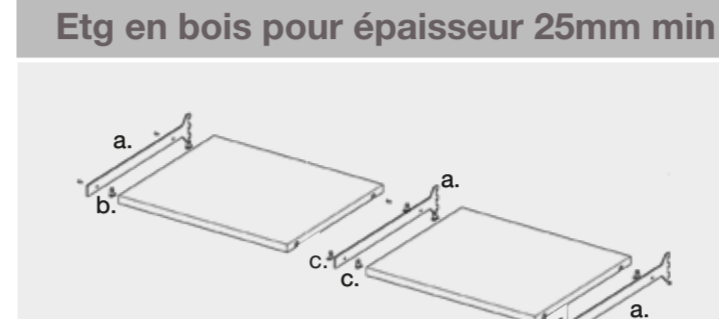
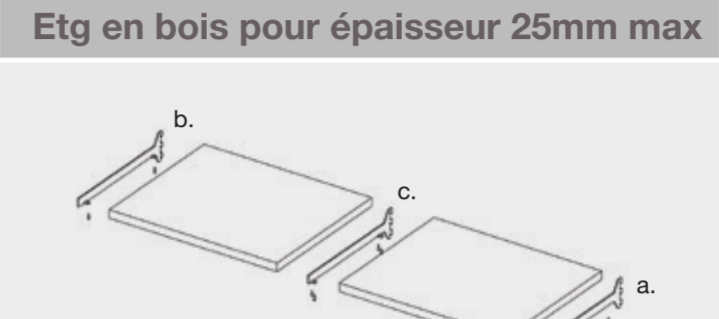

	Kit de niveau de réglage <b>DB802.008.003</b>
--	--

	Kit de supports pour panneau de base ép. 25mm min Fixation externe x2 pour un panneau de base <b>CS001.012.001</b> Fixation centrale x1 pour deux panneaux de base <b>CS001.012.002</b>
---	---

**ÉTAGÈRE EN BOIS**

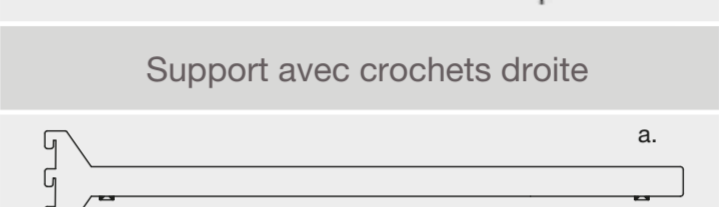
	Etg en bois pour épaisseur 25mm min Supports universels <b>CS001.011.002</b>		Etg en bois pour épaisseur 25mm max Support avec crochets droite <b>CS001.002.061</b>		Tube de cintre pour étagère en bois Tube de cintre à découper 3000mm <b>WA061.003.009</b>
---	--	---	---	---	---

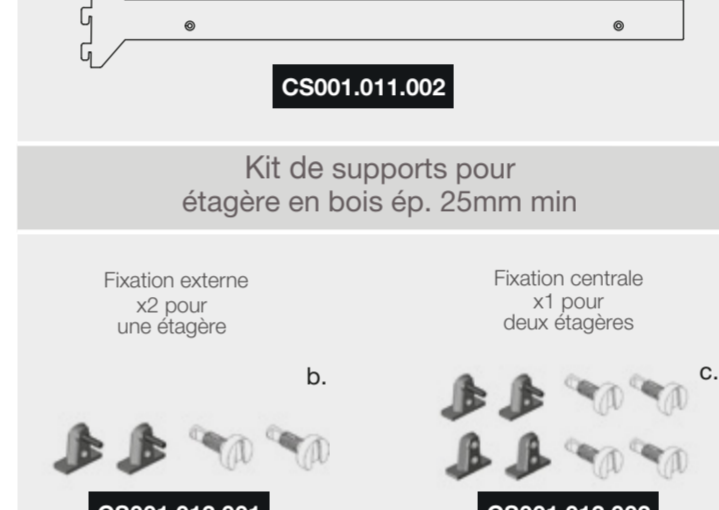
	Kit de supports pour étagère en bois ép. 25mm min Fixation externe x2 pour une étagère Fixation centrale x1 pour deux étagères <b>CS001.012.001</b> <b>CS001.012.002</b>		Support avec crochets gauche <b>CS001.002.060</b>		Set de supports de tube de cintre fixation invisible <b>WA061.003.054</b>
---	--	---	--	---	--

	Support avec crochets central <b>CS001.002.062</b>		<b>CS001.012.001</b> <b>CS001.012.002</b>		<b>CS001.012.001</b> <b>CS001.012.002</b>
--	---	--	--	--	--

**MIXBOX H100**

	<b>Mixbox H100 pré-monté</b> Mixbox H100 pré-monté Module 900 (883 x 448 x 103mm) <b>HP156.111.002</b> Mixbox H100 pré-monté Module 600 (583 x 448 x 103mm) <b>HP156.111.005</b>	<b>Mixbox H100 sur mesure</b> Profil à découper Mixbox H100 (3000mm) <b>HP156.002.004</b> Set de raccords d'angle <b>HP156.003.001</b>	Coulisses 420mm Droit <b>HP156.004.004</b> Gauche <b>HP156.004.003</b>	Supports pour Mixbox H100 x2 pour un Mixbox x3 pour deux Mixbox <b>CS001.121.002</b>
--	--	--	--	---



**MIXBOX H200**



	<b>Mixbox H200 pré-monté</b> Mixbox H200 pré-monté Module 900 (883 x 448 x 200mm) <b>HP156.112.002</b> Mixbox H200 pré-monté Module 600 (583 x 448 x 200mm) <b>HP156.112.005</b>	<b>Mixbox H200 sur mesure</b> Profil à découper Mixbox H200 (3000mm) <b>HP156.011.004</b> Set de raccords d'angle <b>HP156.003.001</b>	Coulisses 420mm Droit <b>HP156.004.004</b> Gauche <b>HP156.004.003</b>	Supports pour Mixbox H200 x2 pour un Mixbox x3 pour deux Mixbox <b>CS001.123.002</b>
--	--	--	--	---

**PORTE-PANTALON**

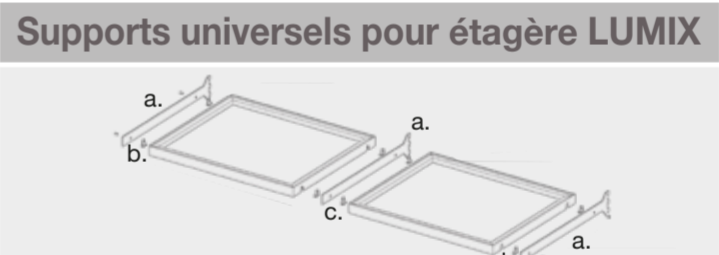
	Porte-pantalons Module 900 + Mixbox H100 pré-monté Module 900 <b>HP156.009.005</b> <b>HP156.111.002</b>	Porte-pantalons Module 600 + Mixbox H100 pré-monté Module 600 <b>HP156.009.002</b> <b>HP156.111.005</b>
--	---	---

**ÉTAGÈRE EN ALUMINIUM LUMIX**

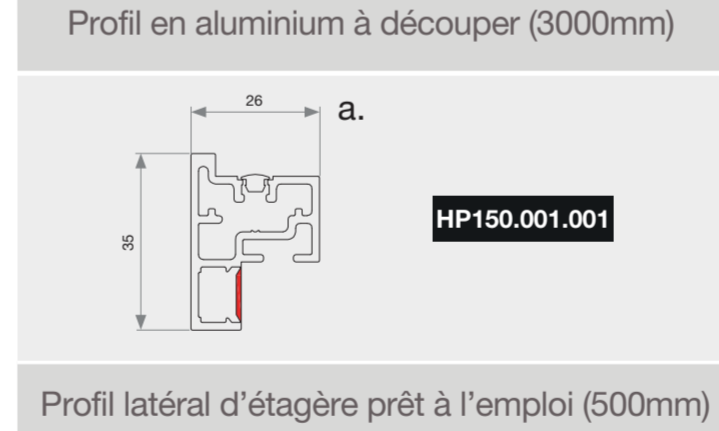
	Profils d'étagère LUMIX Profil en aluminium à découper (3000mm) <b>HP150.001.001</b>		Supports universels pour étagère LUMIX Supports universels <b>CS001.011.002</b>		Tube de cintre pour étagère LUMIX Tube de cintre à découper 3000mm+ support de tube de cintre fixation supérieure <b>WA061.003.009</b> <b>WA061.003.010</b>
---	--	---	---	---	--

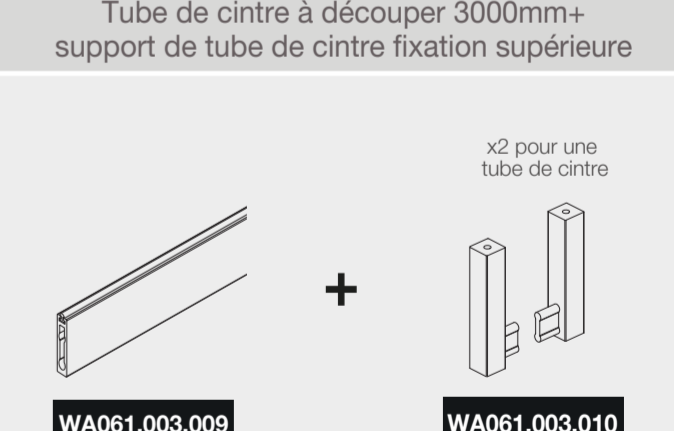
	Profil latéral d'étagère prêt à l'emploi (500mm) x2 pour une étagère LUMIX <b>HP150.010.002</b> x2 pour une étagère LUMIX <b>HP150.010.002</b>		Kit de supports pour étagère LUMIX Fixation externe x2 pour une étagère LUMIX <b>HP150.004.003</b> Fixation centrale x1 pour deux étagères LUMIX <b>HP150.004.002</b>		Set de connecteurs de tube de cintre x1 set pour une tube de cintre <b>HP150.003.006</b>
---	--	---	---	---	--

	Set de raccords d'angle x1 set pour une étagère LUMIX <b>HP150.003.004</b>		<b>HP150.004.003</b> <b>HP150.004.002</b>		<b>HP150.003.006</b>
---	--	---	--	---	----------------------

# DRESSING

V1.24.13

## PROFILÉS EN ALUMINIUM POUR PORTE EN VERRE

### Porte de dressing avec charnière 30kg

		Profil à charnière (21x30x3000mm)  HH165.004.001	Profil à poignée (21x40x3000mm)  HH165.003.001	Set de raccords d'angle  HH165.002.004	Charnière 30kg droite  HH165.001.003	Charnière 30kg gauche  HH165.001.004	Joint en caoutchouc pour verre (3000mm)  HP011.010.001	Support de fixation de la charnière (En option)  HH165.005.001
--	--	--	--	--	--	--	--	--

**i** : verre non inclus

### Porte de cuisine avec charnière 20kg

		Profil à charnière (18x28x3000mm)  HH148.003.002	Profil à poignée (18x38x3000mm)  HH148.009.002	Set de raccords d'angle  HH148.002.001	Charnière 20kg droite  HH148.001.001	Charnière 20kg gauche  HH148.001.002	Joint en caoutchouc pour verre (3000mm)  HP011.010.001
--	--	--	--	--	--	--	--

## TETRIX STRUCTUREL

### Profils pour tetricx structurel

		Profil avant (25x68x2650mm)  HP161.001.002	Profil arrière (25x45x2650mm)  HP161.003.002	Profil horizontal supérieur et inférieur à découper (25x12x3000mm) + Kit de fixation  HP161.004.004	Kit de fixation pour profil supérieur et inférieur  HP161.005.001	Profil horizontal intermédiaire à découper 3000mm ou prêt à l'emploi 465mm  HP157.014.004	Raccords pour profil intermédiaire  HP161.110.005	Joint silicone gris foncé (3000mm)  HP161.110.008	HP161.008.001	Set de Raccordement  DB802.008.001
--	--	--	--	---	---	---	---	---	---------------	--

**i** : verre non inclus

### Profil de panneau arrière en verre

		Joint en caoutchouc pour verre à découper (3000mm)  HP011.010.001
--	--	---

**Siège social CASABLANCA**  
Tél.: +212 5 22 94 36 34  
Fax: +212 5 22 94 36 15  
E-mail: contact@revetou.com  
Adresse: 51 rue Attabari, 20100, Maarif - Maroc

**Succursale MARRAKECH**  
Tél.: +212 5 24 33 62 01  
Fax: +212 5 24 33 52 80  
E-mail: marrakech@revetou.com  
Adresse: 264, Zone Industrielle, Sidi Ghanem, Maroc

**Succursale RABAT**  
Tél.: +212 5 37 79 69 16  
Fax: +212 5 37 79 69 58  
E-mail: rabat@revetou.com  
Adresse: 34 Av. Fadila Yac, Al Mansour 10052 - Maroc

www.revetou.com    Revêtou    revetou\_mar

## MIXBOX H100

	Mixbox H100 prémonté		Mixbox H100 sur mesure	Coulisses 420mm
	Mixbox H100 prémonté Module 900 (883x448x103mm)  HP156.111.002	Mixbox H100 prémonté Module 600 (583x448x103mm)  HP156.111.005	Profil à découper Mixbox H100 (3000mm)  HP156.002.004	
				Droit HP156.004.004 Gauche HP156.004.003

## MIXBOX H200

	Mixbox H200 prémonté		Mixbox H200 sur mesure	Coulisses 420mm
	Mixbox H200 prémonté Module 900 (883 x 448 x 200mm)  HP156.112.002	Mixbox H200 prémonté Module 600 (583 x 448 x 200mm)  HP156.112.005	Profil à découper Mixbox H200 (3000mm)  HP156.011.004	
				Droit HP156.004.004 Gauche HP156.004.003

## PORTE-PANTALON

	Porte-pantalons Module 900 + Mixbox H100 prémonté Module 900		Porte-pantalons Module 600 + Mixbox H100 prémonté Module 600	
	 HP156.009.005	 HP156.111.002	 HP156.009.002	 HP156.111.005

## ÉTAGÈRE EN ALUMINIUM LUMIX

	Étagère LUMIX			
	Profilé en aluminium à découper (3000mm)  HP150.001.001	Profil latéral d'étagère prêt à l'emploi (500mm)  HP150.010.002	Set de raccords d'angle  HP150.003.004	Kit de supports pour étagère LUMIX  HP150.004.004

	Tube de cintre pour étagère LUMIX		
	Tube de cintre à découper 3000mm  WA061.003.009	Support de tube de cintre - fixation supérieure  WA061.003.010	Set de connecteurs de tube de cintre  HP150.003.006

## ÉTAGÈRE EN BOIS

	Tube de cintre pour étagère en bois		
	Tube de cintre à découper 3000mm  WA061.003.009	Set de supports de tube de cintre Fixation invisible  WA061.003.054	Kit de supports pour étagère en bois ép. 25mm min  JB089.008.004